

Electrical Specifications

Voltage: 6 VDC
Duty Cycle: Continuous
Resistance: 38 ohms \pm 10% (@ 20c)
Amps @ rated Volts: 0.17
Watts @ rated Volts: 1.0
Holding: 6 lbs (1/4" Thick 1215 CRS @ 20c)
Operating Temp: -40c to 60c (range)

Additional Components

Screw: N/A
Spring: N/A
Spiral Pin: N/A
Potting: N/A

Finish: Housing - Zinc or Electroless Nickel Plating
 (0.0002-0.0003")

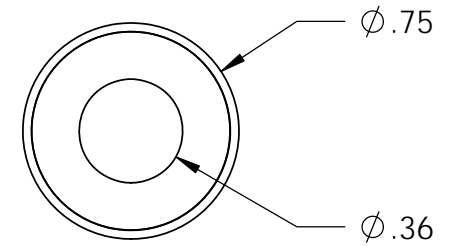

18" Long Leads
 26 Ga. Teflon Type E

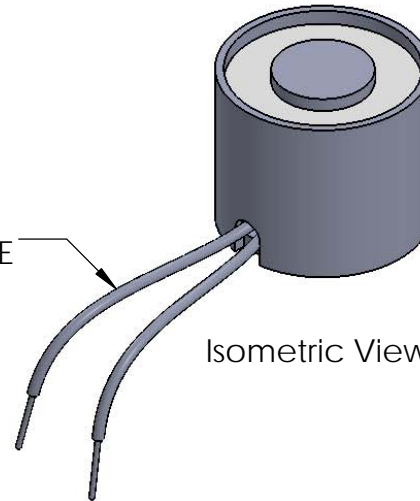

Isometric View

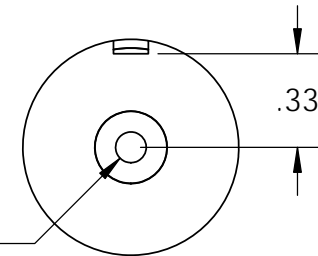
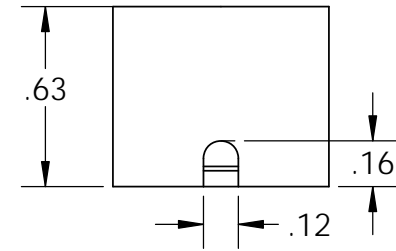

ϕ .11 ∇ .51
 6-32 UNC ∇ .35

PROPRIETARY AND CONFIDENTIAL
 THE INFORMATION CONTAINED IN THIS DRAWING IS THE SOLE PROPERTY OF APW COMPANY. ANY REPRODUCTION IN PART OR AS A WHOLE WITHOUT THE WRITTEN PERMISSION OF APW COMPANY IS PROHIBITED.

		UNLESS OTHERWISE SPECIFIED:		NAME	DATE	APW COMPANY	
		DIMENSIONS ARE IN INCHES		DRAWN	K.H.	08.10.11	TITLE: EM075-6-222
		TOLERANCES:		CHECKED	J.K.	08.10.11	
		FRACTIONAL \pm .015		ENG APPR.	J.K.	08.10.11	
		ANGULAR: MACH \pm 2 BEND \pm 2		MFG APPR.	J.K.	08.10.11	
		TWO PLACE DECIMAL \pm .005		Q.A.			SIZE DWG. NO. REV A 6035
		THREE PLACE DECIMAL \pm .003		COMMENTS:			
		INTERPRET GEOMETRIC TOLERANCING PER: ANSI					SCALE: 1:1 WEIGHT: SHEET 1 OF 1
		MATERIAL					
			FINISH				
	NEXT ASSY	USED ON					
	APPLICATION		DO NOT SCALE DRAWING				